



## Welcome to the Kwikset family!

This guide will get you ready to install your new knob.

If you have any issues, please visit our support center: [kwikset.com/support](http://kwikset.com/support) or call us at 1-800-327-5625.

**This manual can be used to install a variety of knobs.  
Please determine your function type prior to installation.**



**Passage**  
(Hall/ Closet)



**Privacy**  
(Bed/ Bath)



**Entry**  
(Keyed)



**Inactive**  
(Non-Rotating)

\*Tools

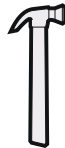
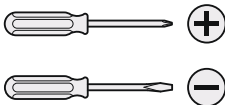

wood block

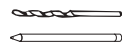
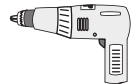

\*Tools will depend on install type

[Door Prep: If you need help in preparing your door](#)  
[Drilling template: If you need help in drilling your door](#)

# 1 Separate knobs (if pre-assembled)

If installing a non-rotating knob, skip to step 4

A

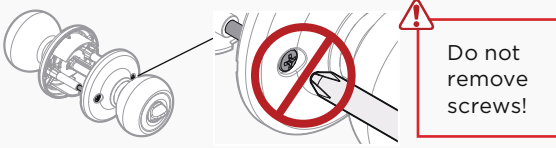

B

Twist the side with the holes.

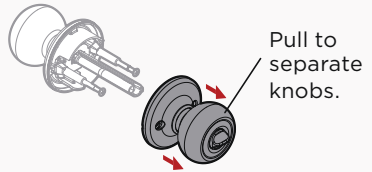
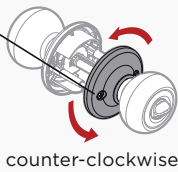

C

Set knobs aside until step 4.

# 2 Adjust the backset of the latch (if needed)

A

Hold the latch in front of the door hole, with the latch face flush against the door edge.



B

If the latch holes are centered in the door hole, no adjustment is required. Proceed to step 3.

If the latch holes are NOT centered, adjust latch. See "Latch Adjustment" (step C).

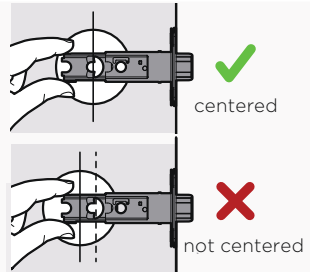

C

Latch Adjustment (only if needed)

Move the pin to extend the latch.

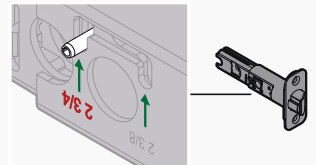
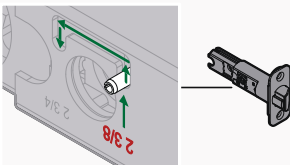

### 3 Install latch (chiseled door)

A

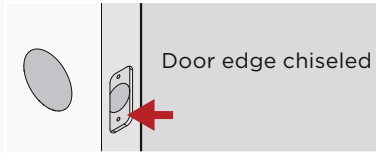

B

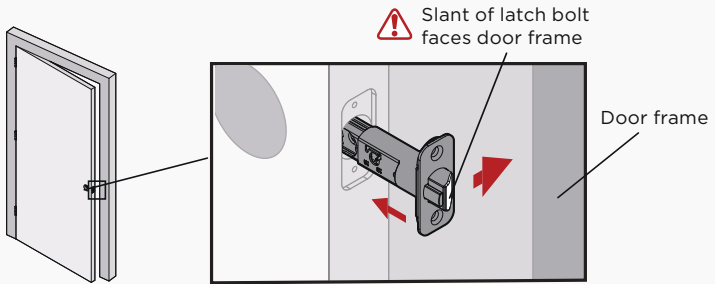

C

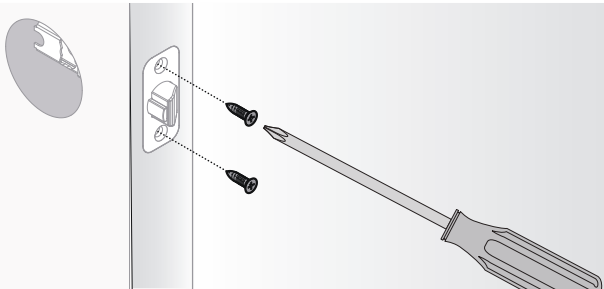

### 3 Install latch (non-chiseled door)

A



B

Remove plates with flat head screwdriver

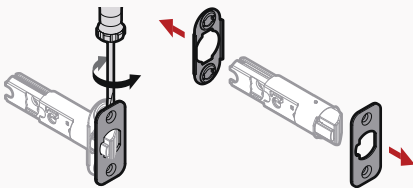

C

Install drive-in collar

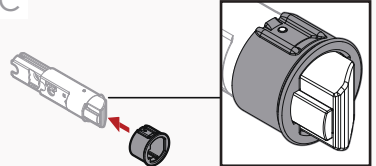

D

Use hammer and wood block to tap in latch without damaging it.

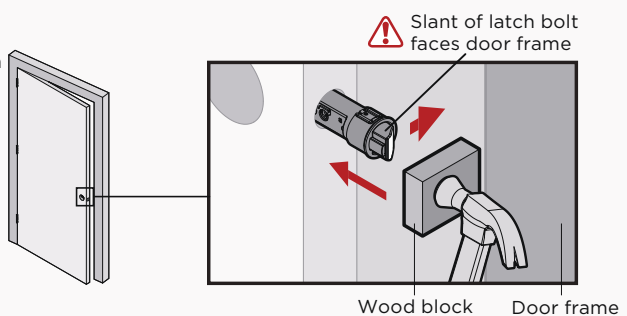



Installation instructions differ by knob design. For traditional styled knobs, follow directions below. For contemporary knobs, please proceed to page 6.

Installing Passage, Privacy or Entry traditional knobs, proceed to the next page.

***Option 4a: Install passage, & privacy knobs***



**Passage**  
(Hall/ Closet)



**Privacy**  
(Bed/ Bath)

***Option 4b: Install entry knobs***



**Entry**  
(Keyed)

Installing Inactive knobs, proceed to page 8, step 4d.

***Option 4d: Install inactive knobs***



**Inactive**  
(Non-Rotating)

## 4 Install traditional styled knobs:

*Option 4a: Install passage, & privacy knobs then proceed to step 5*

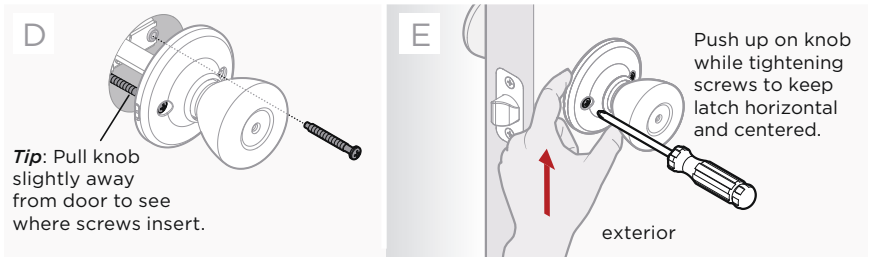
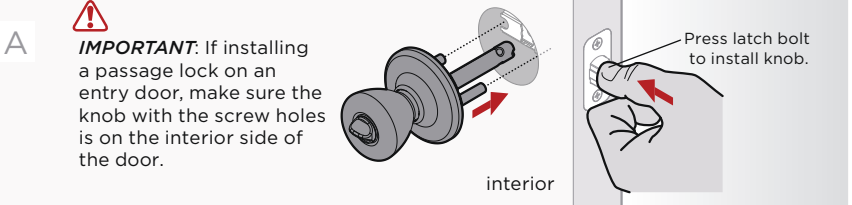

*Option 4b: Install entry knobs then proceed to step 5*

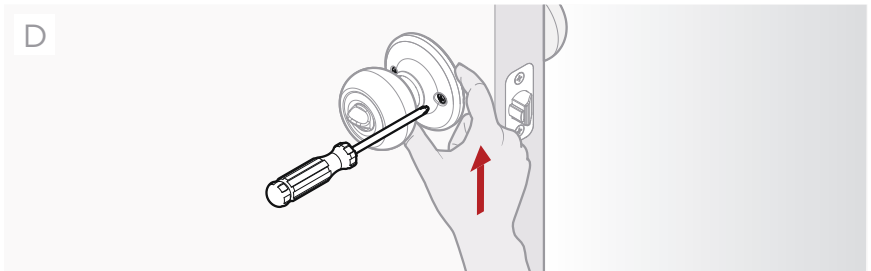
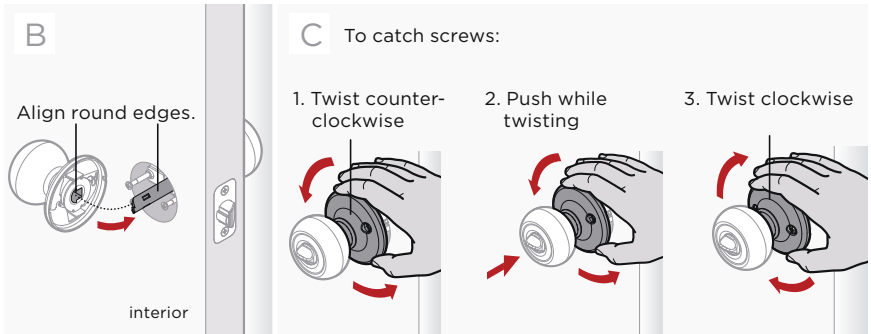
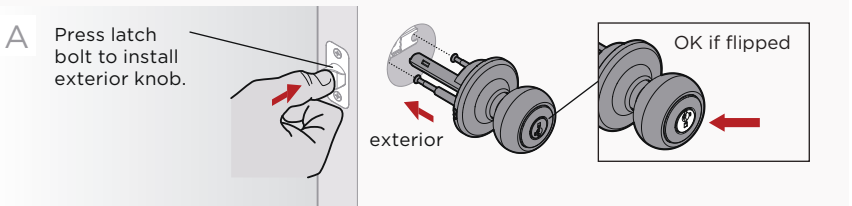

If installing a contemporary knob (shown below),  
proceed to the next page.

***Option 4c: Install passage, privacy, & entry knobs***



# 4

## Install contemporary styled knobs: Passage, Privacy & Entry

Option 4c: Install passage, privacy, & entry knobs then proceed to [step 5](#)

A Press latch bolt to install exterior knob.

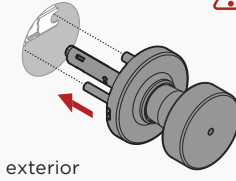

**! IMPORTANT:** If installing a passage lock on an entry door, make sure the knob with the screw holes is on the interior side of the door.

B Remove knob.

Loosen the pre-installed set screw.

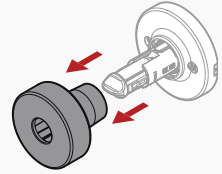

C Install interior knob base.

Align round edges.

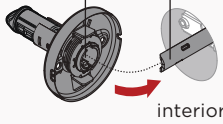

D If the knob won't sit flush, rotate turnbutton to align.

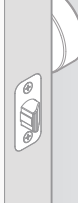
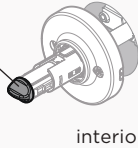

E Insert screws and tighten by hand.

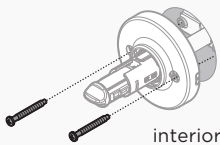

**Tip:** Pull knob slightly away from door to see where screws insert.

F Push up on knob base while tightening screws to keep latch horizontal and centered.

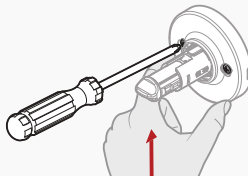

G Install knob.

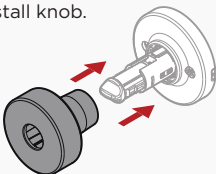

Tighten the pre-installed set screw.

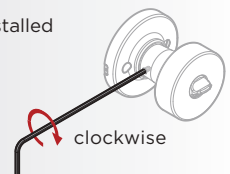

## For Privacy Locks ONLY

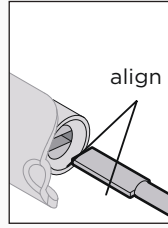
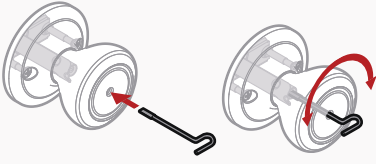

Save the bedroom/bathroom emergency unlock tool for future use.

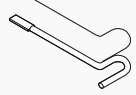

## 4 Install inactive (non-rotating) knobs

*Option 4d: Install inactive knobs then proceed to [step 5](#)*

- A** Mark drill holes using the knob, then drill 1/8" (3 mm) 1/2" (13 mm) deep.

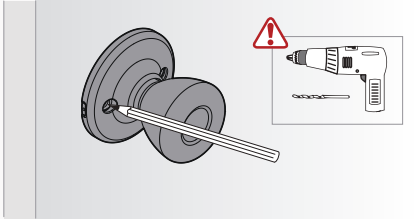

**B**

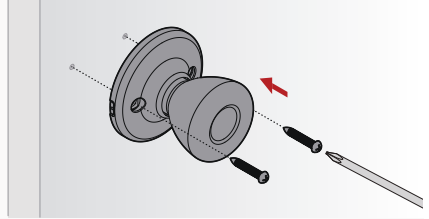

## 5 Install strike to door frame

**A**

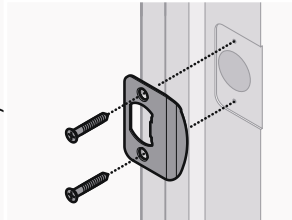
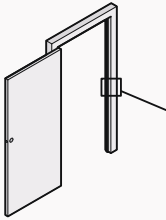

- B** Close door, test latch operation and make adjustments as needed:

If small bolt of latch enters strike hole, reposition strike.

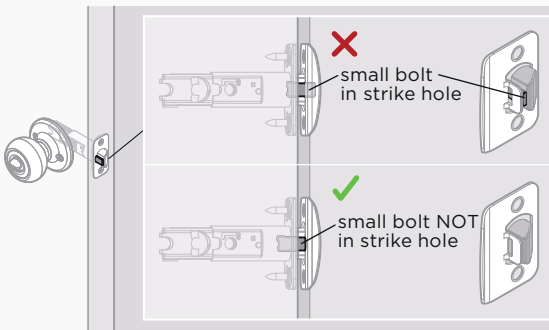

If latch is loose in the strike, adjust the strike tab so it grips the latch bolt better when the door is closed.

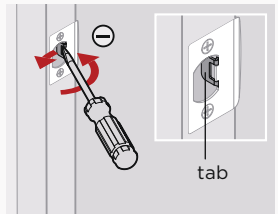



# SmartKey Rekeying Instructions



**SMARTKEY**  
**SECURITY™**

**ONE KEY  
FOR ALL  
YOUR LOCKS™**

Easily re-key  
yourself

Reset tool  
goes here



The lock you can  
re-key yourself in  
seconds for any  
situation, including:



**Recently  
Moved**



**Lost  
Keys**



**Multiple  
Doors**



**Carry  
Less Keys**

WITH PROTECTION AGAINST  
ADVANCED BREAK-IN TECHNIQUES

For rekeying instructions, you can also visit:

<https://www.kwikset.com/support/answers/how-to-re-key-your-smartkey-security-locks>

If you have any issues, please visit our  
support center: [kwikset.com/support](https://www.kwikset.com/support)  
or call us at 1-800-327-5625.



**WARNING:** This Manufacturer advises that no lock can provide complete security by itself. This lock may be defeated by forcible or technical means, or evaded by entry elsewhere on the property. No lock can substitute for caution, awareness of your environment, and common sense. Builder's hardware is available in multiple performance grades to suit the application. In order to enhance security and reduce risk, you should consult a qualified locksmith or other security professional.